

Ceilings*



- LED spots:
- Up to 100 000 hours and reduces energy consumption by 80% vs. halogen spots.
 - Constant light quality
 - Remain cool in operation

FLT: Fluorescent tubes
HAL: Halogen spot lights
LED: LED spot lights



Walls*

STAINLESS STEEL

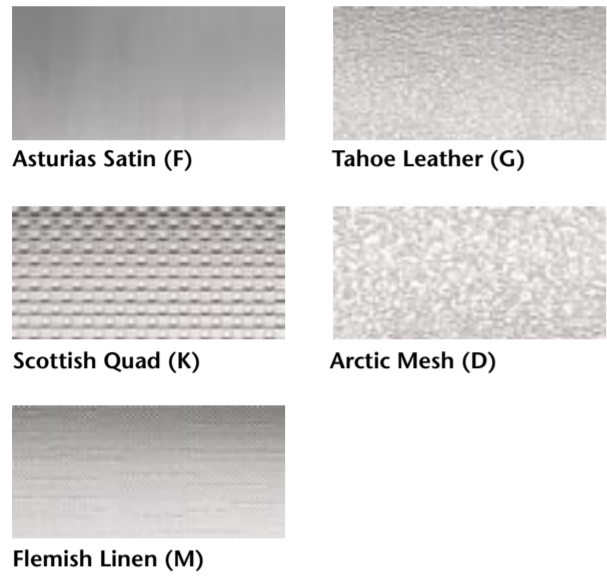

COATED METAL



LAMINATE



WOOD VENEER

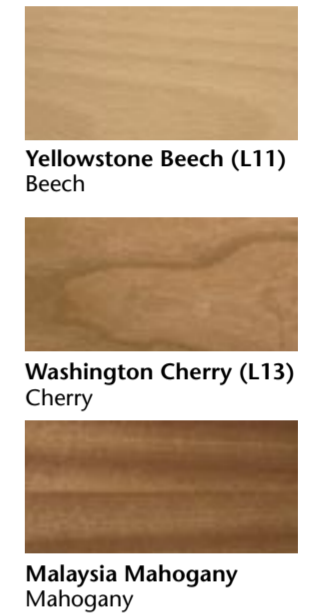

Floors*

RUBBER

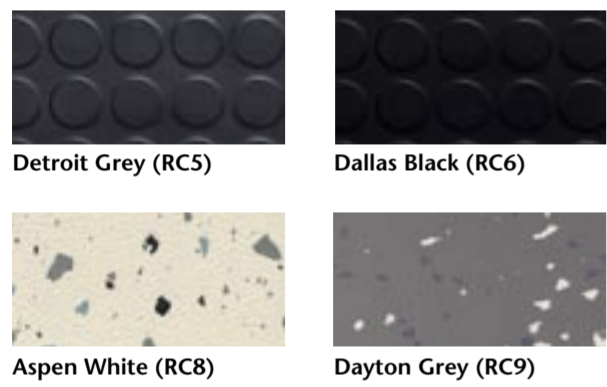

COMPOSITE STONE

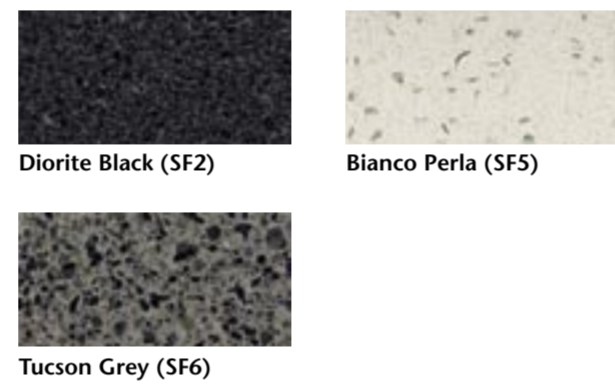

LAMINATE

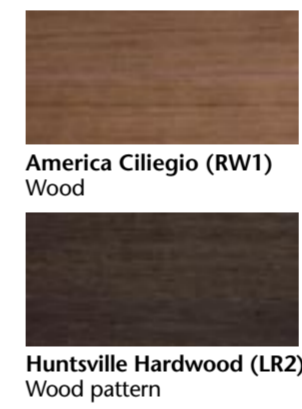

Skirting



- Made of Asturias Satin (F) Stainless steel or Murano Mirror (H) Stainless steel.
- Finished at every end and corner with metal caps.

Handrails

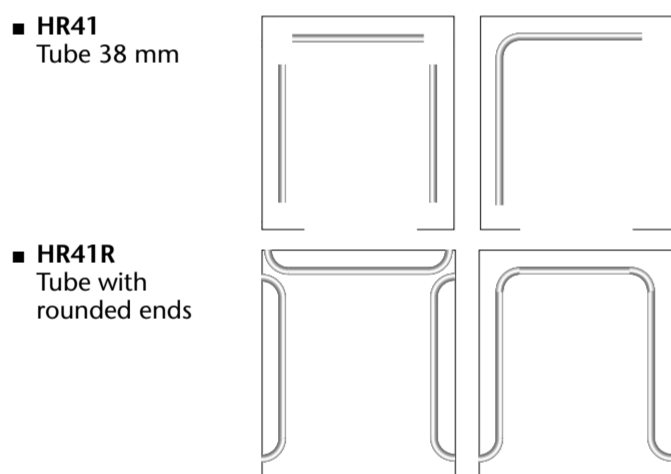

- HR41, HR41T, HR41R and HR41TR are made of Asturias Satin (F) Stainless steel or Murano Mirror (H) stainless steel
- HR41 is also available in wood finishing America Ciliegio (RW1) or Huntsville Hardwood (LR2)

Chair



- Wooden or black plastic
- Rear or side wall
- Not on the same wall as handrail

Mirrors



- Can be placed on rear and/or side wall
- Glass panel (smoked or clear): partial or full height. Partial width and partial height only standard cars up to 630 kg with car height 2100 mm
- Mirrors with profile fixings

Windows



- Can be full or partial width
- Partial height is not available
- Full width only for cars with width up 1400 mm
- Stainless steel handrail is mandatory
- Window frame is aluminium

Car and Landing signalization

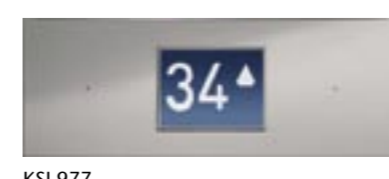

Landing doors*

Stainless steel: Asturias Satin (F), Flemish Linen (M), Scottish Quad (K), Arctic Mesh (D), Tahoe Leather (G), Murano Mirror (H).

Coated metal: Monterrey Silver (R1), Silicon Grey (R2), Astoria Almond (R10).

KES200, KES600 and KES800 are available. Glass doors only with KES600/800.

Features

- KES 200: frame and front
- KES 600: if glass door, full front or EN81-72 compliant door is requested.

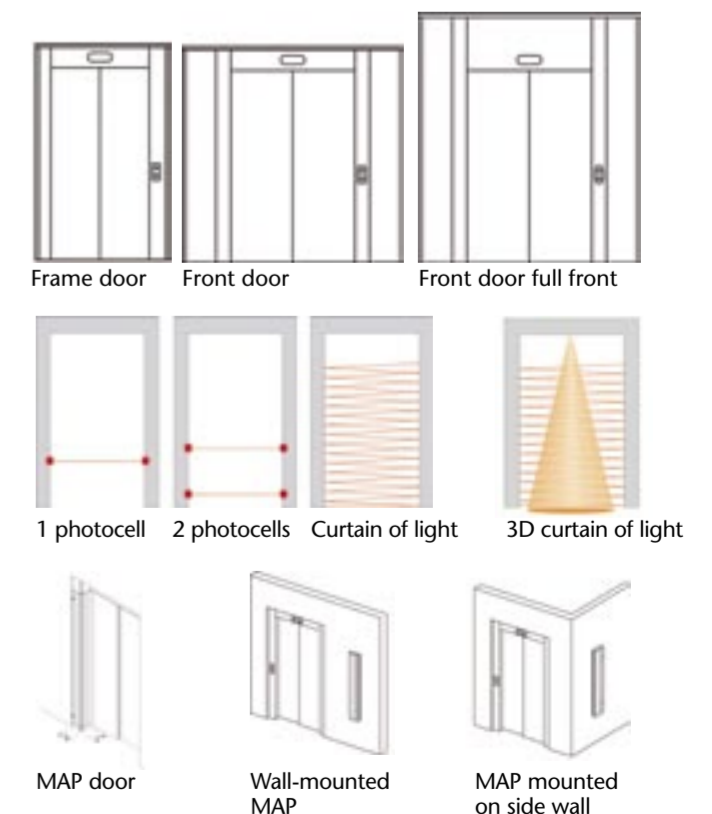

- Maintenance and rescue operations are integrated in a small cabinet
- Integrated at topmost landing door or one floor below
- Finishing in Asturias Satin, Scottish Quad, Flemish Linen or zinc coated
- To allow more flexibility a wall-mounted solution can be supplied
- Can be located on the side wall of the shaft
- Finishing in aluminium or stainless steel

*Zinc coated (z) finishing is also available, to be painted locally by the customer.